



E-LIKE INDUSTRIAL (HONG KONG) LIMITED

CE EMC REPORT

Prepared For :	E-LIKE INDUSTRIAL (HONG KONG) LIMITED RM 905 Workingberg Commercial Building 41-47 Marble Road North Point, HongKong
Product Name:	HDMI ACTIVE OPTICAL CABLE
Trade Name:	Savlink
Model :	SHDC-8700-100, SHDC-8700-010, SHDC-8700-020, SHDC-8700-030, SHDC-8700-040, SHDC-8700-050, SHDC-8700-060, SHDC-8700-070, SHDC-8700-080, SHDC-8700-090
Prepared By :	Shenzhen BST Technology Co., Ltd. Building No.23-24, Zhiheng Industrial Park, Guankouer Road, Nantou,Nanshan District,Shenzhen,Guangdong,China
Test Date:	Aug. 12-16, 2016
Date of Report :	Aug. 16, 2016
Report No.:	BSTDG1608651630001ER-1



TABLE OF CONTENTS

TEST REPORT DECLARATION	5
1. TEST RESULTS SUMMARY	7
2. GENERAL INFORMATION	8
2.1. Report information	8
2.2. Measurement Uncertainty	8
3. PRODUCT DESCRIPTION	9
3.1. EUT Description.....	9
3.2. Block Diagram of EUT Configuration	9
3.3. Operating Condition of EUT	9
3.4. Test Conditions.....	9
3.5. Modifications.....	9
3.6. Abbreviations	10
3.7. Performance Criterion	10
4. TEST EQUIPMENT USED	11
4.1. For Conducted Emission Test	11
4.2. For Radiated Emission Measurement.....	11
4.3. For Harmonic / Flicker Test	11
4.4. For Electrostatic Discharge Immunity Test.....	11
4.5. For RF Strength Susceptibility Test	11
4.6. For Electrical Fast Transient/Burst Immunity Test	12
4.7. For Surge Test	12
4.8. For Injected Currents Susceptibility Test	12
4.9. For Magnetic Field Immunity Test.....	12
4.10. For Voltage Dips and Interruptions Test	12
5. POWER LINE CONDUCTED EMISSION TEST	13
5.1. Block Diagram of Test Setup	13
5.2. Test Standard.....	13
5.3. Power Line Conducted Emission Limit	13
5.4. EUT Configuration on Test.....	13
5.5. Operating Condition of EUT	14
5.6. Test Procedure	14
5.7. Test Result.....	14
6. RADIATED EMISSION TEST	15
6.1. Open Site Setup Diagram	15
6.2. Test Standard.....	15
6.3. Radiated Emission Limit	15
6.4. EUT Configuration on Test.....	15
6.5. Operating Condition of EUT	16
6.6. Test Procedure	16
6.7. Test Results	16
7. HARMONIC CURRENT EMISSION TEST	17
7.1. Block Diagram of Test Setup	17
7.2. Test Standard and Limit	17
7.3. Test Procedure	18



7.4. Test Results18

8. VOLTAGE FLUCTUATIONS & FLICKER TEST19

8.1. Block Diagram of Test Setup19

8.2. Test Standard.....19

8.3. Operating Condition of EUT19

8.4. Test Results19

9. ELECTROSTATIC DISCHARGE TEST.....20

9.1. Block Diagram of ESD Test Setup.....20

9.2. Test Standard.....20

9.3. Severity Levels and Performance Criterion.....20

9.4. EUT Configuration on Test.....20

9.5. Operating Condition of EUT20

9.6. Test Procedure21

9.7. Test Results21

10. RF FIELD STRENGTH SUSCEPTIBILITY TEST23

10.1. R/S Test Setup.....23

10.2. Test Standard.....23

10.3. Severity Levels and Performance Criterion.....23

10.4. EUT Configuration on Test.....24

10.5. Operating Condition of EUT24

10.6. Test Procedure24

10.7. Test Results24

11. ELECTRICAL FAST TRANSIENT/BURST TEST.....26

11.1. EFT Test Setup.....26

11.2. Test Standard.....26

11.3. Severity Levels and Performance Criterion.....26

11.4. EUT Configuration on Test.....26

11.5. Operating Condition of EUT26

11.6. Test Procedure27

11.7. Test Results27

12. SURGE TEST29

12.1. Surge Test Setup.....29

12.2. Test Standard.....29

12.3. Severity Levels and Performance Criterion.....29

12.4. EUT Configuration on Test.....29

12.5. Operating Condition of EUT29

12.6. Test Procedure30

12.7. Test Results30

13. INJECTED CURRENTS SUSCEPTIBILITY TEST32

13.1. Block Diagram of Test AC Mains Setup.....32

13.2. Test Standard.....32

13.3. Severity Levels and Performance Criterion.....32

13.4. EUT Configuration on Test.....32

13.5. Operating Condition of EUT32

13.6. Test Procedure33

13.7. Test Results33

14. MAGNETIC FIELD IMMUNITY TEST.....35

14.1. Block Diagram of Test Setup35



14.2. Test Standard	35
14.3. Severity Levels and Performance Criterion.....	35
14.4. EUT Configuration on Test.....	35
14.5. Operating Condition of EUT	36
14.6. Test Procedure	36
14.7. Test Results	36
15. VOLTAGE DIPS AND INTERRUPTIONS TEST	38
15.1. Voltage Dips and Interruptions Test Setup	38
15.2. Test Standard	38
15.3. Severity Levels and Performance Criterion.....	38
15.4. EUT Configuration on Test.....	38
15.5. Operating Condition of EUT	38
15.6. Test Procedure	39
15.7. Test Result.....	39
APPENDIX I	41
APPENDIX II.....	44



TEST REPORT DECLARATION

Applicant	:	E-LIKE INDUSTRIAL (HONG KONG) LIMITED
Address	:	RM 905 Workingberg Commercial Building 41-47 Marble Road North Point, HongKong
EUT Description	:	HDMI ACTIVE OPTICAL CABLE
Trade Name	:	Savlink
Model Number	:	SHDC-8700-100, SHDC-8700-010, SHDC-8700-020, SHDC-8700-030, SHDC-8700-040, SHDC-8700-050, SHDC-8700-060, SHDC-8700-070, SHDC-8700-080, SHDC-8700-090 (Note: The series products have the same circuit diagram, PCB layout and functionality. The differences are the model name and appearance, so, we select SHDC-8700-100 to test.)



Test Standards:

- EN 55032:2015,
- EN 61000-3-2:2014 & EN 61000-3-3:2013
- EN 55024:2010
- (EN 61000-4-2:2009, EN 61000-4-3:2006+A1:2008+A2:2010,
- EN 61000-4-4:2012, EN 61000-4-5:2014,
- EN 61000-4-6:2014, EN 61000-4-8:2010, EN 61000-4-11:2004)

The EUT described above is tested by BST Technology Co., Ltd. EMC Laboratory to determine the maximum emissions from the EUT and ensure the EUT to be compliance with the immunity requirements of the EUT. BST Technology Co., Ltd. EMC Laboratory is assumed full responsibility for the accuracy of the test results. Also, this report shows that the EUT technically complies with the 2014/30/EU directive and its amendment requirements.

The test report is valid for above tested sample only and shall not be reproduced in part without written approval of the laboratory.

Prepared by :

Grace

Assistant

Tested by:

Jane.zhu

Test Engineer

Reviewer :

Diana

Supervisor

Approved & Authorized Signer :

Christina Deng

Christina Deng/ Manager



1. TEST RESULTS SUMMARY

Table 1 Test Results Summary

Test Items	Test Results
Radiated Emission	PASS
Conducted Disturbance	N/A
Harmonic Current	N/A
Voltage Fluctuation and Flicker	N/A
Electrostatic Discharge Immunity	PASS
Radiated Electromagnetic Fields Immunity	PASS
Electric Fast Transient Burst Immunity	N/A
Surge Immunity	N/A
Injected currents susceptibility test	N/A
Magnetic Field Immunity Test	PASS
Voltage dips and interruptions Immunity	N/A



2. GENERAL INFORMATION

2.1. Report information

- 2.1.1. This report is not a certificate of quality; it only applies to the sample of the specific product/equipment given at the time of its testing. The results are not used to indicate or imply that they are application to the similar items. In addition, such results must not be used to indicate or imply that BST approves recommends or endorses the manufacture, supplier or use of such product/equipment, or that BST in any way guarantees the later performance of the product/equipment.
- 2.1.2. The sample/s mentioned in this report is/are supplied by Applicant, BST therefore assumes no responsibility for the accuracy of information on the brand name, model number, origin of manufacture or any information supplied.
- 2.1.3. Additional copies of the report are available to the Applicant at an additional fee. No third part can obtain a copy of this report through BST, unless the applicant has authorized BST in writing to do so.

2.2. Measurement Uncertainty

Available upon request.



3. PRODUCT DESCRIPTION

3.1. EUT Description

Description	:	HDMI ACTIVE OPTICAL CABLE
Applicant	:	E-LIKE INDUSTRIAL (HONG KONG) LIMITED RM 905 Workingberg Commercial Building 41-47 Marble Road North Point, HongKong
Manufacturer	:	RELIABLE PHOTONICS (SHENZHEN) CO., LTD 7F, Building 8, Yusheng Industrial Park, Gushu, Xixiang Town, Bao'an District, Shenzhen, PRC
Model Number	:	SHDC-8700-100, SHDC-8700-010, SHDC-8700-020, SHDC-8700-030, SHDC-8700-040, SHDC-8700-050, SHDC-8700-060, SHDC-8700-070, SHDC-8700-080, SHDC-8700-090

3.2. Block Diagram of EUT Configuration

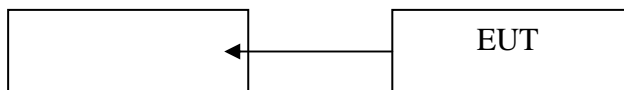

3.3. Operating Condition of EUT

Test mode 1: ON

3.4. Test Conditions

Temperature: 23-26°C

Relative Humidity: 55-68 %

3.5. Modifications

No modification was made.



3.6. Abbreviations

AC	Alternating Current
AMN	Artificial Mains Network
DC	Direct Current
EM	ElectroMagnetic
EMC	ElectroMagnetic Compatibility
EUT	Equipment Under Test
IF	Intermediate Frequency
RF	Radio Frequency
rms	root mean square
EMI	Electromagnetic Interference
EMS	Electromagnetic Susceptibility

3.7. Performance Criterion

Criterion A: The equipment shall continue to operate as intended without operator intervention. No degradation of performance or loss of function is allowed below a performance level specified by the manufacturer when the equipment is used as intended.

Criterion B: After the test, the equipment shall continue to operate as intended without operator intervention. No degradation of performance or loss of function is allowed, after the application of the phenomena below a performance level specified by the manufacturer, when the equipment is used as intended.

Criterion C: Loss of function is allowed, provided the function is self-recoverable, or can be restored by the operation of the controls by the user in accordance with the manufacturer's instructions.



4. TEST EQUIPMENT USED

4.1. For Conducted Emission Test

Item	Equipment	Manufacturer	Model No.	Serial No.	Last Cal.	Cal. Interval
1.	Test Receiver	Rohde & Schwarz	ESHS30	828985/018	Jun. 01, 16	1 Year
2.	Pulse Limiter	Rohde & Schwarz	ESH3-Z2	100006	Jun. 01, 16	1 Year
3.	L.I.S.N.	Rohde & Schwarz	ESH2-Z5	834549/005	Jun. 01, 16	1 Year
4.	Conical	Emtek	N/A	N/A	N/A	N/A
5.	Voltage Probe	Schwarzbeck	TK9416	N/A	Jun. 01, 16	1 Year
6.	Coaxial Switch	Anritsu	MP59B	6100214550	Jun. 01, 16	1 Year

4.2. For Radiated Emission Measurement

Item	Equipment	Manufacturer	Model No.	Serial No.	Last Cal.	Cal. Interval
1.	Spectrum Analyzer	ANRITSU	MS2661C	6200140915	Jun 01,16	1 Year
2.	Test Receiver	Rohde&Schwarz	ESC830	828982/018	Jun 01,16	1 Year
3.	Bilog Antenna	Schwarzbeck	VULB9163	142	Jun 01,16	1 Year
4.	50 Coaxial Switch	Anritsu Corp	MP59B	6100237248	Jun 01,16	1 Year
5.	Cable	Schwarzbeck	AK9513	ACRX1	Jun 01,16	1 Year
6.	Cable	Rosenberger	N/A	FR2RX2	Jun 01,16	1 Year
7.	Cable	Schwarzbeck	AK9513	CRRX2	Jun 01,16	1 Year
8.	Cable	Schwarzbeck	AK9513	CRRX2	Jun 01,16	1 Year
9.	Signal Generator	HP	864A	3625U00573	Jun 01,16	1 Year

4.3. For Harmonic / Flicker Test

Item	Equipment	Manufacturer	Model No.	Serial No.	Last Cal.	Cal. Interval
1.	Power Frequency test system	HAEFELY	PHF555	080419-03	Jun 01,16	1 Year

4.4. For Electrostatic Discharge Immunity Test

Item	Equipment	Manufacturer	Model No.	Serial No.	Last Cal.	Cal. Interval
1.	ESD Tester	HAEFELY	PSD 1600	H911'292	Jun. 02, 16	1 Year

4.5. For RF Strength Susceptibility Test

Item	Equipment	Manufacturer	Model No.	Serial No.	Last Cal.	Cal. Interval
1.	Signal Generator	HP	8648A	3633A02081	Jun. 03, 16	1 Year
2.	Amplifier	A&R	500A100	17034	NCR	NCR
3.	Amplifier	A&R	100W/1000M1	17028	NCR	NCR
4.	Isotropic Field Monitor	A&R	FM2000	16829	NCR	NCR
5.	Isotropic Field Probe	A&R	FLW220100	16755	Jun. 03, 16	1 Year
6.	Biconic Antenna	EMCO	3108	9507-2534	NCR	NCR
7.	Log-periodic Antenna	A&R	AT1080	16812	NCR	NCR
8.	PC	N/A	486DX2	N/A	N/A	N/A



4.6. For Electrical Fast Transient/Burst Immunity Test

Item	Equipment	Manufacturer	Model No.	Serial No.	Last Cal.	Cal. Interval
1.	Burst Tester	HAEFELY	PEFT 4010	080981-16	Jun 01,16	1 Year

4.7. For Surge Test

Item	Equipment	Manufacturer	Model No.	Serial No.	Last Cal.	Cal. Interval
1.	Surge Tester	HAEFELY	PSURGE4.1	080107-04	Jun 01,16	1 Year

4.8. For Injected Currents Susceptibility Test

Item	Equipment	Manufacturer	Model No.	Serial No.	Last Cal.	Cal. Interval
1.	Simulator	EMTEST	CWS 500C	0900-12	Jun 01,16	1 Year
2.	CDN	EMTEST	CDN-M2	510010010010	Jun 01,16	1 Year
3.	VDN	EMTEST	CDN-M3	0900-11	Jun 01,16	1 Year
4.	Injection Clamp	EMTEST	F-2031-23MM	368	Jun 01,16	1 Year
5.	Attenuator	EMTEST	ATT6	0010222a	Jun 01,16	1 Year

4.9. For Magnetic Field Immunity Test

Item	Equipment	Manufacturer	Model No.	Serial No.	Last Cal.	Cal. Interval
1.	Magnetic Field Tester	HAEFELY	MAG100.1	083858-10	Jun 01,16	1 Year

4.10. For Voltage Dips and Interruptions Test

Item	Equipment	Manufacturer	Model No.	Serial No.	Last Cal.	Cal. Interval
2.	Dips Tester	HAEFELY	PLINE 1610	083732-18	Jun. 01,16	1 Year



5. POWER LINE CONDUCTED EMISSION TEST

5.1. Block Diagram of Test Setup

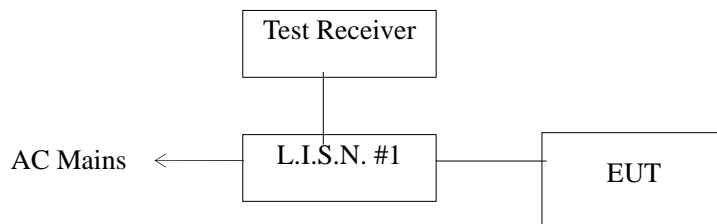

5.2. Test Standard

EN 55032:2015

5.3. Power Line Conducted Emission Limit

Frequency MHz	Limits dB(μV)	
	Quasi-peak Level	Average Level
0.15 ~ 0.50	66 ~ 56*	56 ~ 46*
0.50 ~ 5.00	56	46
5.00 ~ 30.00	60	50

Notes: 1. *Decreasing linearly with logarithm of frequency.

2. The lower limit shall apply at the transition frequencies.

5.4. EUT Configuration on Test

The following equipments are installed on conducted emission test to meet EN55032 requirement and operating in a manner, which tends to maximize its emission characteristics in a normal application.

5.4.1. EUT Information

Model Number : SHDC-8700-100
Serial Number : N/A
Manufacturer : RELIABLE PHOTONICS (SHENZHEN) CO., LTD



5.5. Operating Condition of EUT

- 5.5.1. Setup the EUT and simulators as shown in Section 5.1.
- 5.5.2. Turn on the power of all equipments.
- 5.5.3. Let the EUT work in test modes (ON) and test it.

5.6. Test Procedure

The EUT is put on the ground and connected to the AC mains through a Artificial Mains Network (AMN). This provided 50ohm-coupling impedance for the tested equipments. Both sides of AC line are checked to find out the maximum conducted emission levels according to the EN55032 regulations during conducted emission test.

The bandwidth of the test receiver (R&S Test Receiver ESHS30) is set at 10KHz.

The frequency range from 150 KHz to 30 MHz is investigated.

5.7. Test Result

N/A

6. RADIATED EMISSION TEST

6.1. Open Site Setup Diagram

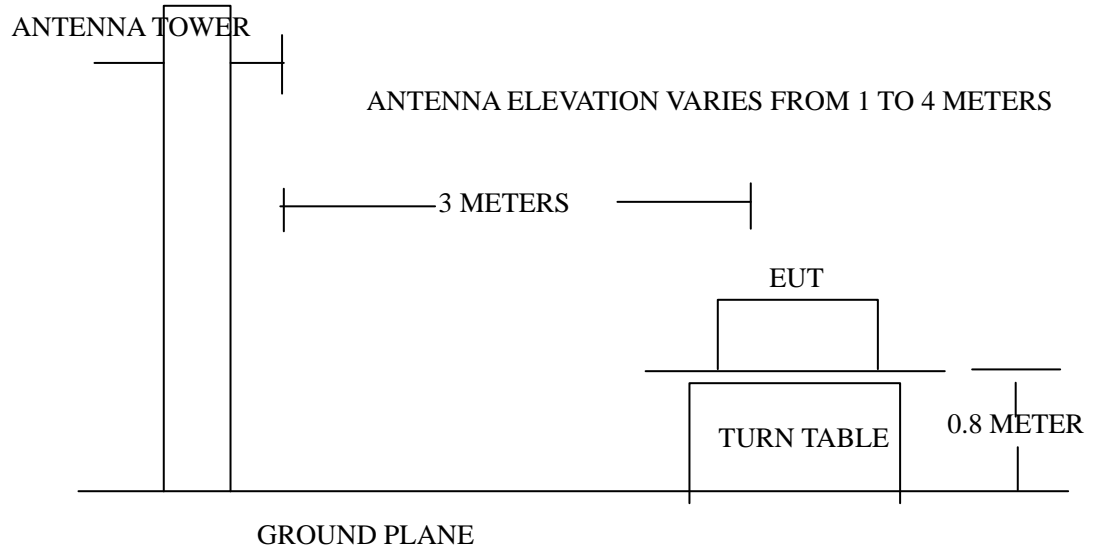

6.2. Test Standard

EN 55032:2015

6.3. Radiated Emission Limit

All emanations from a Class B computing devices or system, including any network of conductors and apparatus connected thereto, shall not exceed the level of field strengths specified below:

FREQUENCY (MHz)	DISTANCE (Meters)	FIELD STRENGTHS LIMITS (dB μ V/m)
30 ~ 230	3	40
230 ~ 1000	3	47

Note:(1) The tighter limit shall apply at the edge between two frequency bands.

(2) Distance refers to the distance in meters between the measuring instruments antenna and the closed point of any part of the EUT.

6.4. EUT Configuration on Test

The EN55032 Class B regulations test method must be used to find the maximum emission during radiated emission test.



6.5. Operating Condition of EUT

- 6.5.1. Setup the EUT as shown on Section 6.1.
- 6.5.2. Turn on the power of all equipments.
- 6.5.3. Let the EUT work in test mode and measure it.

6.6. Test Procedure

The EUT is placed on a turn table which is 0.8 meter above ground. The turn table can rotate 360 degrees to determine the position of the maximum emission level. The EUT is set 3 meters away from the receiving antenna which is mounted on a antenna tower. The antenna can move up and down between 1 to 4 meters to find out the maximum emission level. Broadband antenna (calibrated by dipole antenna) are used as a receiving antenna. Both horizontal and vertical polarization of the antenna are set on test.

The bandwidth setting on the test receiver (R&S TEST RECEIVER ESCS20) is 120 KHz.

The EUT is tested in Semi-Anechoic Chamber. and all the scanning waveform is put in

Appendix I.

6.7. Test Results

PASS.



7. HARMONIC CURRENT EMISSION TEST

7.1. Block Diagram of Test Setup

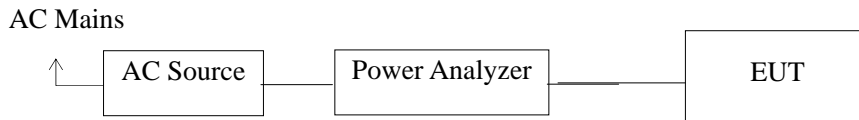

7.2. Test Standard and Limit

7.2.1. Test Standard

EN 61000-3-2:2014

7.2.2. Limits

Table 12 Harmonic Current Test Limit (Class A)

Harmonic order (n)	Maximum permissible harmonic current (A)
Odd harmonics	
3	2.30
5	1.14
7	0.77
9	0.40
11	0.33
13	0.21
15 ≤ n ≤ 39	0.15 × 15/n
Even harmonics	
2	1.08
4	0.43
6	0.30
8 ≤ n ≤ 40	0.23 × 8/n



7.3. Test Procedure

The power cord of the EUT is connected to the output of the test system. Turn on the Power of the EUT and use the test system to test the harmonic current level.

7.4. Test Results

N/A



8. VOLTAGE FLUCTUATIONS & FLICKER TEST

8.1. Block Diagram of Test Setup

Same as Section 7.1..

8.2. Test Standard

EN61000-3-3:2013

8.3. Operating Condition of EUT

Same as Section 7.3.. The power cord of the EUT is connected to the output of the test system. Turn on the power of the EUT and use the test system to test the harmonic current level.

Flicker Test Limit

Test items	Limits
Pst	1.0
dc	3.3%
dmax	4.0%
dt	Not exceed 3.3% for 500ms

8.4. Test Results

N/A



9. ELECTROSTATIC DISCHARGE TEST

9.1. Block Diagram of ESD Test Setup

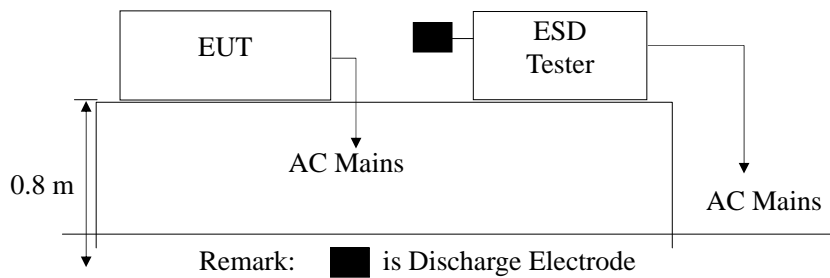

9.2. Test Standard

EN 55024:2010 (EN61000-4-2:2009)
 Severity Level 3 for Air Discharge at 8KV
 Severity Level 2 for Contact Discharge at 4KV

9.3. Severity Levels and Performance Criterion

9.3.1. Severity level

Level	Test Voltage Contact Discharge (KV)	Test Voltage Air Discharge (KV)
1.	2	2
2.	4	4
3.	6	8
4.	8	15
X.	Special	Special

9.3.2. Performance criterion: B

9.4. EUT Configuration on Test

The configuration of EUT are listed in Section 5.4

9.5. Operating Condition of EUT

- 9.5.1. Setup the EUT as shown in Section 9.1.
- 9.5.2. Turn on the power of all equipments.
- 9.5.3. Let the EUT work in test mode (ON) and test it.



9.6. Test Procedure

9.6.1. Air Discharge:

This test is done on a non-conductive surfaces. The round discharge tip of the discharge electrode shall be approached as fast as possible to touch the EUT.

After each discharge, the discharge electrode shall be removed from the EUT.

The generator is then re-triggered for a new single discharge and repeated 10 times for each pre-selected test point. This procedure shall be repeated until all the air discharge completed.

9.6.2. Contact Discharge:

All the procedure shall be same as Section 9.6.1. except that the tip of the discharge electrode shall touch the EUT before the discharge switch is operated.

9.6.3. Indirect discharge for horizontal coupling plane

At least 20 single discharges shall be applied to the horizontal coupling plane, at points on each side of the EUT. The discharge electrode positions vertically at a distance of 0.1m from the EUT and with the discharge electrode touching the coupling plane.

9.6.4. Indirect discharge for vertical coupling plane

At least 20 single discharge shall be applied to the center of one vertical edge of the coupling plane. The coupling plane, of dimensions 0.5m X 0.5m, is placed parallel to, and positioned at a distance of 0.1m from the EUT. Discharges shall be applied to the coupling plane, with this plane in sufficient different positions that the four faces of the EUT are completely illuminated.

9.7. Test Results

PASS.

Please refer to the following page.



Electrostatic Discharge Test Results

Shenzhen BST Technology Co., Ltd.

<i>Applicant</i> : E-LIKE INDUSTRIAL (HONG KONG) <i>LIMITED</i>	<i>Test Date</i> : Aug.12,2016
<i>EUT</i> : HDMI ACTIVE OPTICAL CABLE	<i>Temperature</i> : 22 °C
<i>M/N</i> : SHDC-8700-100	<i>Humidity</i> : 50 %
<i>Power Supply</i> : -	<i>Test Mode</i> : ON

Air Discharge: ±8KV For each point positive 10 times and negative 10 times discharge.

Contact Discharge: ±4KV

<i>Location</i>	<i>Kind</i> A-Air Discharge C-Contact Discharge	<i>Result</i>
<i>Slots</i>	A	PASS
<i>Metal part</i>	C	PASS
<i>Screw</i>	C	PASS
<i>Port</i>	C	PASS
<i>HCP</i>	C	PASS
<i>VCP</i>	C	PASS

Discharge should be considered on Contact and Air and Horizontal Coupling Plane (HCP) and Vertical Coupling Plane (VCP).

10. RF FIELD STRENGTH SUSCEPTIBILITY TEST

10.1. R/S Test Setup

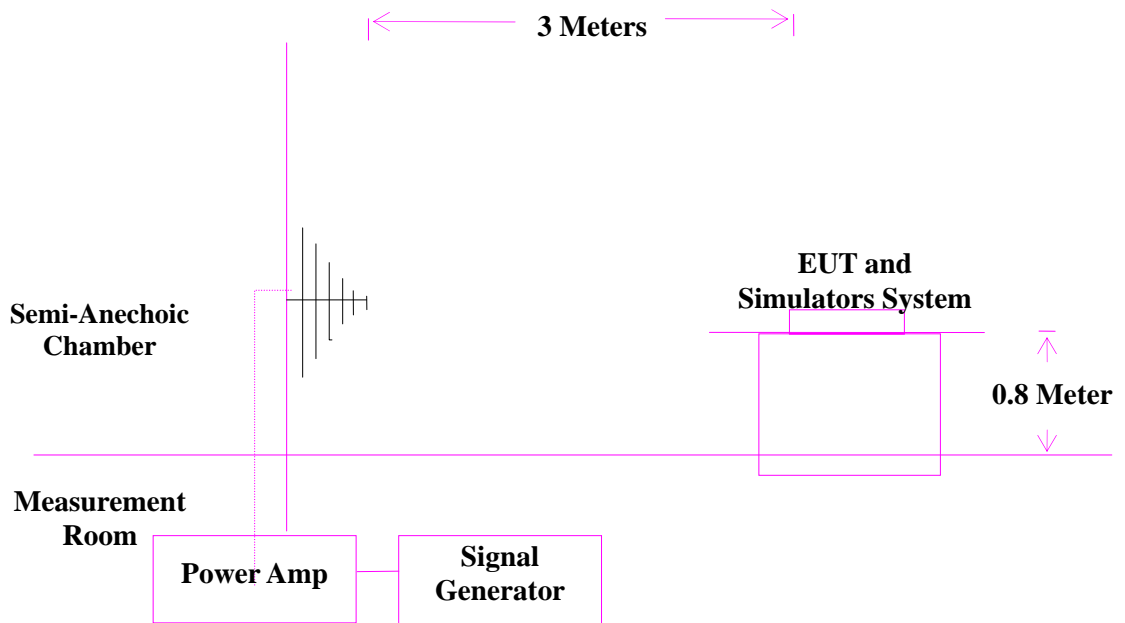

10.2. Test Standard

EN 55024:2010 (EN 61000-4-3:2006+A1:2008+A2:2010)
Severity Level 2 at 3V / m

10.3. Severity Levels and Performance Criterion

10.3.1. Severity level

Level	Field Strength V/m
1.	1
2.	3
3.	10
X.	Special

10.3.2. Performance criterion : A



10.4.EUT Configuration on Test

The configuration of EUT are listed in Section 5.4

10.5.Operating Condition of EUT

Setup the EUT as shown in Section 10.1.. The operating condition of EUT are listed in section 3.3.

10.6.Test Procedure

The EUT and its simulators are placed on a turn table which is 0.8 meter above the ground. The EUT is set 3 meters away from the transmitting antenna which is mounted on an antenna tower. Both horizontal and vertical polarization of the antenna are set on test. Each of the four sides of EUT must be faced this transmitting antenna and measured individually. In order to judge the EUT performance, a CCD camera is used to monitor the EUT. All the scanning conditions are as follows :

Condition of Test	Remarks
1. Fielded Strength	3 V/m (Severity Level 2)
2. Radiated Signal	Modulated
3. Scanning Frequency	80 - 1000 MHz, 1.4 - 2.7 GHz
4. Sweeping time of radiated	0.0015 decade/s
5. Dwell Time	1 Sec.

10.7.Test Results

PASS.

Please refer to the following page.



RF Field Strength Susceptibility Test Results

Shenzhen BST Technology Co., Ltd.

<i>Applicant</i> : E-LIKE INDUSTRIAL (HONG KONG) <i>LIMITED</i>	<i>Test Date</i> : Aug.12,2016
<i>EUT</i> : HDMI ACTIVE OPTICAL CABLE	<i>Temperature</i> : 22 °C
<i>M/N</i> : SHDC-8700-100	<i>Humidity</i> : 50 %
<i>Power Supply</i> : -	<i>Test Mode</i> : ON
<i>Frequency Range</i> : 80 MHz to 1000 MHz 1.4 GHz to 2.7 GHz	
<i>Modulation:</i> <input checked="" type="checkbox"/> AM <input type="checkbox"/> Pulse <input type="checkbox"/> none 1 KHz 80%	
<i>Criterion</i> : A	
	<i>Frequency Rang</i> : 80 MHz to 1000 MHz, 1.4 GHz to 2.7 GHz
<i>Steps</i>	1%
	Horizontal
	Vertical
<i>Front</i>	Pass
<i>Right</i>	Pass
<i>Rear</i>	Pass
<i>Left</i>	Pass

11.ELECTRICAL FAST TRANSIENT/BURST TEST

11.1.EFT Test Setup

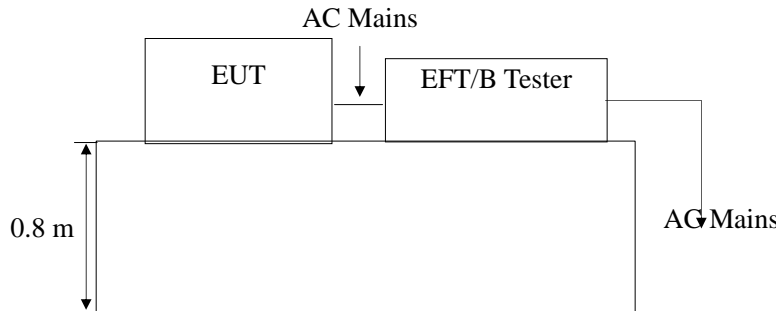

11.2.Test Standard

EN 55024:2010 (EN 61000-4-4:2012)

Severity Level 2 at 1KV

11.3.Severity Levels and Performance Criterion

11.3.1.Severity level

Level	Open Circuit Output Test Voltage $\pm 10\%$	
	On Power Supply Lines	On I/O (Input/Output) Signal data and control lines
1.	0.5 KV	0.25 KV
2.	1 KV	0.5 KV
3.	2 KV	1 KV
4.	4 KV	2 KV
X	Special	Special

11.3.2.Performance criterion : B

11.4.EUT Configuration on Test

The configuration of EUT are listed in Section 5.4.

11.5.Operating Condition of EUT

Setup the EUT as shown in Section 11.1.. The operating condition of EUT are listed in section 3.3.



11.6. Test Procedure

The EUT is put on the table which is 0.8 meter high above the ground. This reference ground plane shall project beyond the EUT by at least 0.1m on all sides and the minimum distance between the EUT and all other conductive structure, except the ground plane beneath the EUT, shall be more than 0.5m.

11.6.1. For input and output AC power ports:

The EUT is connected to the power mains by using a coupling device which couples the EFT interference signal to AC power lines. Both polarities of the test voltage should be applied during compliance test and the duration of the test is 2 mins.

11.6.2. For signal lines and control lines ports:

It's unnecessary to test.

11.6.3. For DC output line ports:

It's unnecessary to test.

11.7. Test Results

N/A



Electrical Fast Transient/Burst Test Results

Shenzhen BST Technology Co., Ltd.

<i>Applicant</i>	: <i>E-LIKE INDUSTRIAL (HONG KONG) LIMITED</i>	<i>Test Date</i>	: <i>Aug.12,2016</i>						
<i>EUT</i>	: <i>HDMI ACTIVE OPTICAL CABLE</i>	<i>Temperature</i>	: <i>22 °C</i>						
<i>M/N</i>	: <i>SHDC-8700-100</i>	<i>Humidity</i>	: <i>50 %</i>						
<i>Power Supply</i>	: -	<i>Test Mode</i>	: <i>ON</i>						
<i>Inject Place : AC Mains</i>									
<i>Inject Line</i>	<i>Voltage KV</i>	<i>Inject Time(s)</i>	<i>Inject Method</i>	<i>Results</i>	<i>Inject Line</i>	<i>Voltage KV</i>	<i>Inject Time(s)</i>	<i>Inject Method</i>	<i>Results</i>
<i>L</i>	<i>±1</i>	<i>120</i>	<i>Direct</i>	<i>--</i>					
<i>N</i>	<i>±1</i>	<i>120</i>	<i>Direct</i>	<i>--</i>					
<i>L N</i>	<i>±1</i>	<i>120</i>	<i>Direct</i>	<i>--</i>					

12.SURGE TEST

12.1.Surge Test Setup

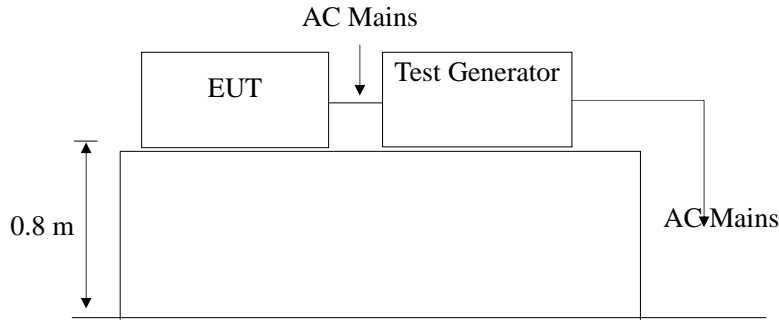

12.2.Test Standard

EN 55024:2010 (EN61000-4-5:2014)
Severity Level 2 for Line to Neutral at 1.0KV

12.3.Severity Levels and Performance Criterion

12.3.1.Severity level

Severity Level	Open-Circuit Test Voltage KV
1	0.5
2	1.0
3	2.0
4	4.0
*	Special

Performance criterion : **B**

12.4.EUT Configuration on Test

The configuration of EUT are listed in Section 5.4

12.5.Operating Condition of EUT

- 12.5.1.Setup the EUT as shown in Section 12.1..
- 12.5.2.Turn on the power of all equipments.
- 12.5.3.Let the EUT work in test mode (ON) and test it.



12.6. Test Procedure

- 1) Setup the EUT and test generator as shown on Section 12.1.
- 2) For line to line coupling mode, provide a 0.5KV 1.2/50us voltage surge (at open-circuit condition) and 8/20us current surge to EUT selected points.
- 3) At least 5 positive and 5 negative (polarity) tests with a maximum 1/min repetition rate are conducted during test.
- 4) Different phase angles are done individually.
- 5) Record the EUT operating situation during compliance test and decide the EUT immunity criterion for above each test.

12.7. Test Results

N/A



Surge Immunity Test Results

Shenzhen BST Technology Co., Ltd.

<i>Applicant</i> : E-LIKE INDUSTRIAL (HONG KONG) <i>LIMITED</i>				<i>Test Date</i> : Aug.12,2016	
<i>EUT</i> : HDMI ACTIVE OPTICAL CABLE				<i>Temperature</i> : 22 °C	
<i>M/N</i> : SHDC-8700-100				<i>Humidity</i> : 50 %	
<i>Power Supply</i> : -				<i>Test Mode</i> : ON	
<i>Location</i>	<i>Polarity</i>	<i>Phase Angle</i>	<i>No of Pulse</i>	<i>Pulse Voltage (KV)</i>	<i>Result</i>
<i>L-N, L-PE, N-PE</i>	+	0	5	1.0	--
	+	90	5	1.0	--
	+	180	5	1.0	--
	+	270	5	1.0	--
	-	0	5	1.0	--
	-	90	5	1.0	--
	-	180	5	1.0	--
	-	270	5	1.0	--

13. INJECTED CURRENTS SUSCEPTIBILITY TEST

13.1. Block Diagram of Test AC Mains Setup

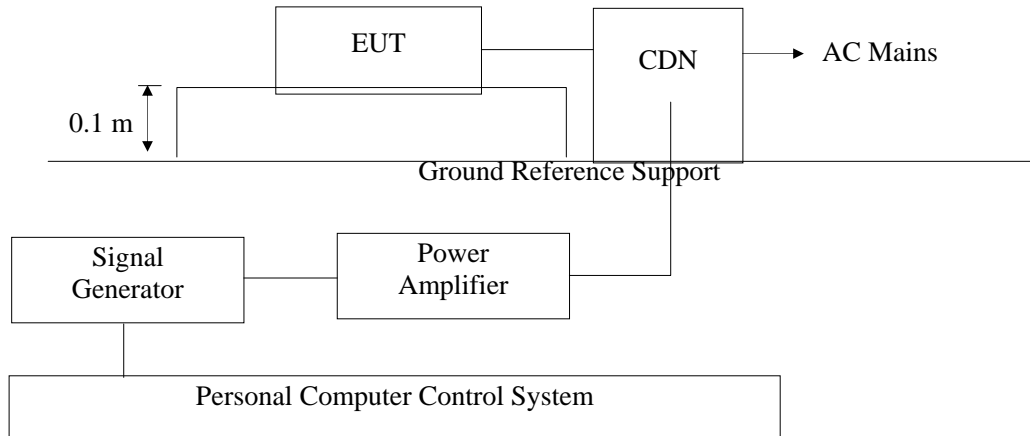

13.2. Test Standard

EN 55024:2010 (EN61000-4-6:2014)
Severity Level 2 at 3 V (rms), 0.15MHz ~ 80MHz

13.3. Severity Levels and Performance Criterion

13.3.1. Severity level

Level	Field Strength V/m
1.	1
2.	3
3.	10
X	Special

13.3.2. Performance criterion: A

13.4. EUT Configuration on Test

The configuration of EUT are listed in Section 5.4

13.5. Operating Condition of EUT

Setup the EUT as shown in Section 13.1.. The operating condition of EUT are listed in section 3.3



13.6. Test Procedure

- 1) Set up the EUT, CDN and test generators as shown on Section 13.1.
- 2) Let the EUT work in test mode and test it.
- 3) The EUT are placed on an insulating support 0.8m high above a ground reference plane. CDN (coupling and decoupling device) is placed on the ground plane about 0.3m from EUT. Cables between CDN and EUT are as short as possible, and their height above the ground reference plane shall be between 30 and 50 mm (where possible).
- 4) The disturbance signal described below is injected to EUT through CDN.
- 5) The EUT operates within its operational mode(s) under intended climatic conditions after power on.
- 6) The frequency range is swept from 150KHz to 80MHz using 3V signal level, and with the disturbance signal 80% amplitude modulated with a 1KHz sine wave.
- 7) The rate of sweep shall not exceed 1.5×10^{-3} decades/s. Where the frequency is swept incrementally, the step size shall not exceed 1% of the start and thereafter 1% of the preceding frequency value.
- 8) Recording the EUT operating situation during compliance testing and decide the EUT immunity criterion.

13.7. Test Results

N/A



Injected Currents Susceptibility Test Results

Shenzhen BST Technology Co., Ltd.

<i>Applicant</i> : E-LIKE INDUSTRIAL (HONG KONG) <i>LIMITED</i>		<i>Test Date</i> : Aug.12,2016		
<i>EUT</i> : HDMI ACTIVE OPTICAL CABLE		<i>Temperature</i> : 22 °C		
<i>M/N</i> : SHDC-8700-100		<i>Humidity</i> : 50 %		
<i>Power Supply</i> : -		<i>Test Mode</i> : ON		
Frequency Range (MHz)	Injected Position	Strength	Criterion	Result
0.15 ~ 20	AC Line	3V(rms), Unmodulated	A	--
20 ~ 80	AC Line	3V(rms), Unmodulated	A	--

14. MAGNETIC FIELD IMMUNITY TEST

14.1. Block Diagram of Test Setup

14.1.1. Block Diagram of the EUT

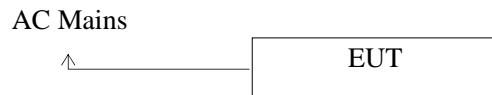

(EUT: HDMI ACTIVE OPTICAL CABLE)

14.1.2. Block Diagram of Test Setup

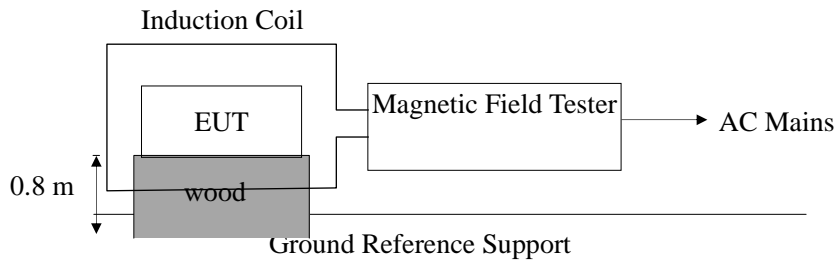

14.2. Test Standard

EN 55024:2010 (EN61000-4-8: 2010)
Severity Level 1 at 1A/m

14.3. Severity Levels and Performance Criterion

14.3.1. Severity level

Level	Magnetic Field Strength A/m
1.	1
2.	3
3.	10
4.	30
5.	100
X.	Special

14.3.2. Performance criterion : A

14.4. EUT Configuration on Test

The configuration of EUT are listed in Section 5.4



14.5. Operating Condition of EUT

- 14.5.1. Setup the EUT as shown in Section 14.1
- 14.5.2. Turn on the power of all equipments.
- 14.5.3. Let the EUT work in test mode (ON) and test it.

14.6. Test Procedure

The EUT shall be subjected to the test magnetic field by using the induction coil of standard dimensions (1m*1m) and shown in Section 14.1. The induction coil shall then be rotated by 90° in order to expose the EUT to the test field with different orientations.

14.7. Test Results

PASS.

Please refer to the following page.



Magnetic Field Immunity Test Results

Shenzhen BST Technology Co.,Ltd.

<i>Applicant : E-LIKE INDUSTRIAL (HONG KONG) LIMITED</i> <i>EUT : HDMI ACTIVE OPTICAL CABLE</i> <i>M/N : SHDC-8700-100</i> <i>Power Supply : -</i>		<i>Test Date : Aug.12,2016</i> <i>Temperature : 22 °C</i> <i>Humidity : 60 %</i>		
<i>Test Model: ON</i>				
<i>Test Level</i>	<i>Testing Duration</i>	<i>Coil Orientation</i>	<i>Criterion</i>	<i>Result</i>
<i>1A/M</i>	<i>5 mins</i>	<i>Horizontal</i>	<i>A</i>	<i>PASS</i>
<i>1A/M</i>	<i>5 mins</i>	<i>Vertical</i>	<i>A</i>	<i>PASS</i>
<i>Remark:</i>		<i>Test Equipment :</i> <i>Magnetic Field Tester MAG100.1</i>		

15. VOLTAGE DIPS AND INTERRUPTIONS TEST

15.1. Voltage Dips and Interruptions Test Setup

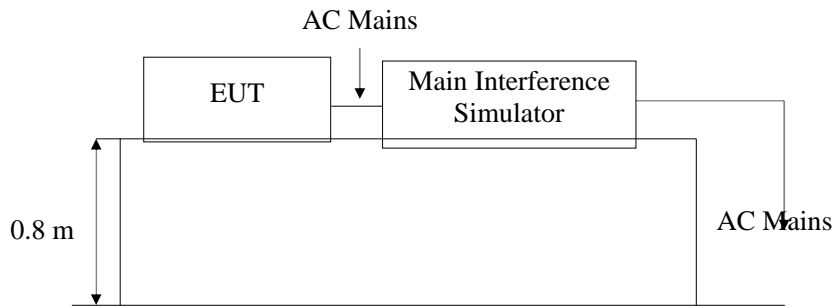

Remark: Combination wave generator and decoupling network are included in test generator.

15.2. Test Standard

EN 55024:2010 (EN61000-4-11:2004)

15.3. Severity Levels and Performance Criterion

15.3.1. Severity level

Test Level %UT	Voltage dip and short interruptions %UT	Duration (in period)
0	100	250p
40	60	5p
70	30	0.5p

15.3.2. Performance criterion : C & B

15.4. EUT Configuration on Test

The configuration of EUT are listed in Section 5.4.

15.5. Operating Condition of EUT

15.5.1. Setup the EUT as shown in Section 15.1.

15.5.2. Turn on the power of all equipments.

15.5.3. Let the EUT work in test mode (ON) and test it.



15.6. Test Procedure

- 1) Set up the EUT and test generator as shown on Section 15.1.
- 2) The interruptions is introduced at selected phase angles with specified duration.
- 3) Record any degradation of performance.

15.7. Test Result

N/A



Voltage Dips And Interruptions Test Results

Shenzhen BST Technology Co., Ltd

<i>Applicant</i>	: <i>E-LIKE INDUSTRIAL (HONG KONG) LIMITED</i>	<i>Test Date</i>	: <i>Aug.12,2016</i>		
<i>EUT</i>	: <i>HDMI ACTIVE OPTICAL CABLE</i>	<i>Temperature</i>	: <i>22 °C</i>		
<i>M/N</i>	: <i>SHDC-8700-100</i>	<i>Humidity</i>	: <i>50 %</i>		
<i>Power Supply</i>	: <i>-</i>	<i>Test Mode</i>	: <i>ON</i>		
<i>Test Level</i> % U_T	<i>Voltage Dips & Short Interruptions</i> % U_T	<i>Duration (in period)</i>	<i>Phase Angle</i>	<i>Criterion</i>	<i>Result</i>
<i>0</i>	<i>100</i>	<i>250P</i>	<i>0° ~360°</i>	<i>C</i>	<i>--</i>
<i>70</i>	<i>30</i>	<i>25P</i>	<i>0° ~360°</i>	<i>C</i>	<i>--</i>
<i>0</i>	<i>100</i>	<i>0.5P</i>	<i>0° ~360°</i>	<i>B</i>	<i>--</i>



APPENDIX I

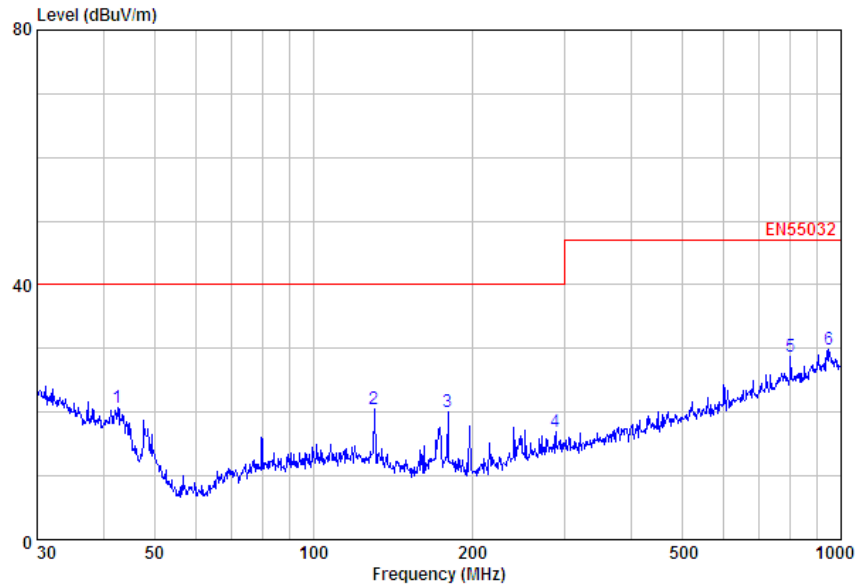

Condition : EN55032 3m HORIZONTAL
 : RBW:120.000KHz VBW:300.000KHz SWT:Auto

	Freq	Level	Remark	Pol/Phase	Limit	Over
	MHz	dBuV/m			dBuV/m	dB
1	42.600	20.6	Peak	HORIZONTAL	40.0	-19.4
2	130.379	20.6	Peak	HORIZONTAL	40.0	-19.4
3	180.017	20.0	Peak	HORIZONTAL	40.0	-20.0
4	287.990	17.0	Peak	HORIZONTAL	40.0	-23.0
5	801.786	28.7	Peak	HORIZONTAL	47.0	-18.3
6 max	948.761	30.0	Peak	HORIZONTAL	47.0	-17.0

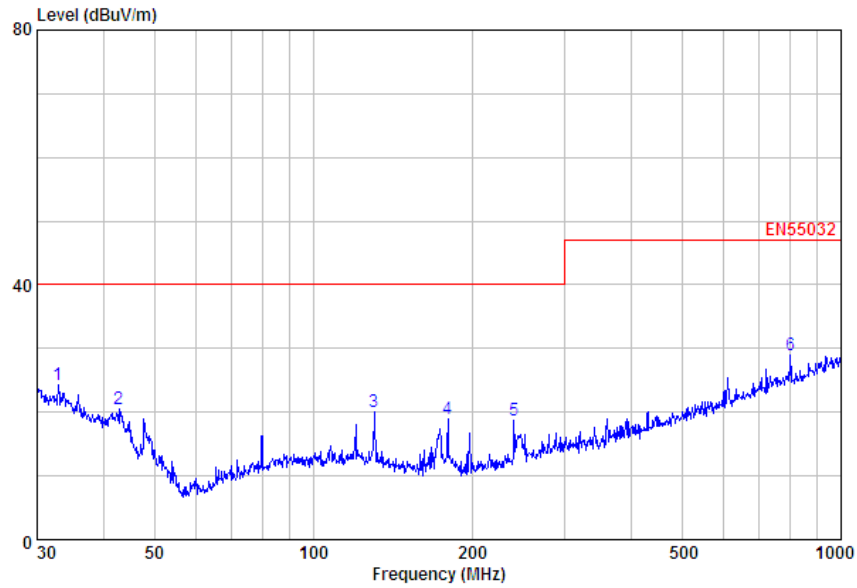

Condition : EN55032 3m VERTICAL
 : RBW:120.000KHz VBW:300.000KHz SWT:Auto

	Freq	Level	Remark	Pol/Phase	Limit	Over
	MHz	dBuV/m			Line	Limit
					dBuV/m	dB
1	max	32.864	24.4 Peak	VERTICAL	40.0	-15.6
2		42.900	20.4 Peak	VERTICAL	40.0	-19.6
3		130.379	20.0 Peak	VERTICAL	40.0	-20.0
4		180.017	19.0 Peak	VERTICAL	40.0	-21.0
5		239.987	18.7 Peak	VERTICAL	40.0	-21.3
6		801.786	29.0 Peak	VERTICAL	47.0	-18.0



APPENDIX II

Photo 1 General Appearance of the EUT

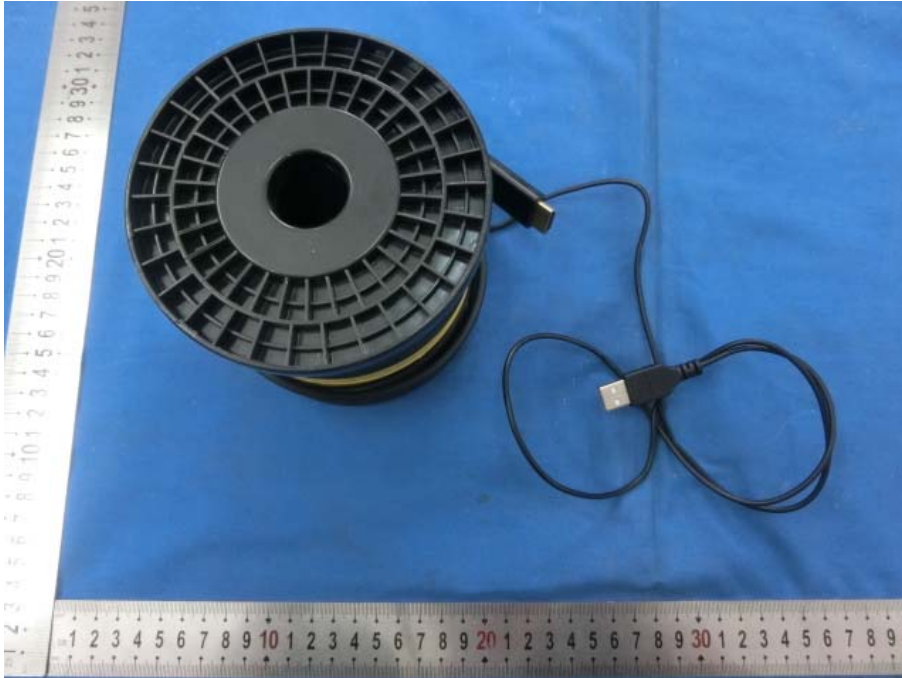

Photo 2 General Appearance of the EUT



Photo 3 General Appearance of the EUT



Photo 4 Test scene

